Smart Pressure Transmitter



Contents

1. General Information.....	1
2. Transportation	2
3. Storage	2
4. Product Identification.....	2
5. Principle	3
6. Mechanical Installation	5
7. Electrical Installation.....	7
8. Use	8
9. Menu Operate	10
10. Maintain	29
11. Repair	29

■ General Information

Smart pressure transmitter is a new high-precision smart transmitter with high-precision silicon pressure sensor which achieves the field device communication by microprocessor.

Smart pressure transmitter includes gauge pressure, differential pressure, absolute pressure, high static pressure, differential pressure, and other varieties.

It widely used in petroleum, chemical, electric power, metallurgy, water, brewing and other industrial fields. For a long time, to the excellent quality of the product and the quality of after-sales service, it has won the unanimous praise of the user.

■ Transportation

After the calibration, the device is packed in a carton (GB / T 13384-2008) in order to protect against damage.

■ Storage

Storage instrument don't need any special treatment. There is no limit on the storage period, but the shelf life is consistent with the period based upon the provisions.

■ Product Identification

The product nameplate identity information includes the serial number, range, accuracy, the input voltage, the output, the date of manufacture and other information.

IMPORTANT: The instrument serial number must be provided in the query.

■ Principle

Figure 1 Gauge pressure transmitter includes two functional units:

- Main unit
- Auxiliary unit

Main unit includes sensor and Process connection, Works as follows: The process medium through a flexible, corrosion resistance of

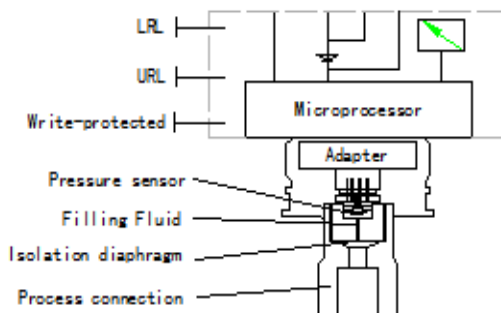

Figure 1 Pressure Transmitter

the isolation diaphragm and the fill fluid pressure is applied on the measuring silicon pressure chip. A termination of the chip connected at the atmosphere (for a gauge pressure measurement) or vacuum (for absolute pressure measurement). When the measured pressure through the measuring diaphragm and the filling liquid is transmitted to the sensor silicon chip, so that the silicon chip of the sensor resistance changes, resulting in change in output voltage of the detection system. this output voltage is proportional to the pressure change. The output is transfer into a standardized signal output by adapter unit and amplifier.

Figure 2 differential pressure transmitter comprises two functional units:

- Main unit
- Auxiliary unit

Main unit includes sensor and Process connection, Works as follows: The transmitter module has an overall internal overload diaphragm, an absolute pressure sensor and a differential pressure sensor with welded technology. Absolute pressure sensor mounted on the higher pressure side of the membrane cartridge of the transmitter module, as a reference value for static pressure compensation. The low pressure chamber of the negative pressure side of the differential pressure sensor is connected to the sensor membrane cartridge. When the measured pressure through the measuring diaphragm and the filling liquid is transmitted to the sensor silicon chip,

so that the silicon chip of the sensor resistance changes, resulting in change in output voltage of the detection system. The output is transfer into a standardized signal output by adapter unit and amplifier.

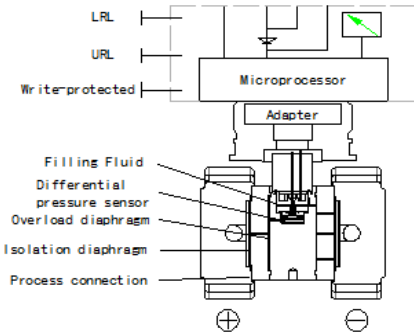

Figure 2 Differential Pressure Transmitter

■ Mechanical Installation

Warning: For the safety of the operators and plant, installation of the transmitter must be performed by trained technicians.

The transmitter housing can be rotated about 360 degrees relative to the transmitter module without affecting the performance and internal wiring. Before rotate the transmitter module, loosen the locking screw with a 2mm Hex wrench, then rotate it to right place and lock the screw again.

Installed as shown below:

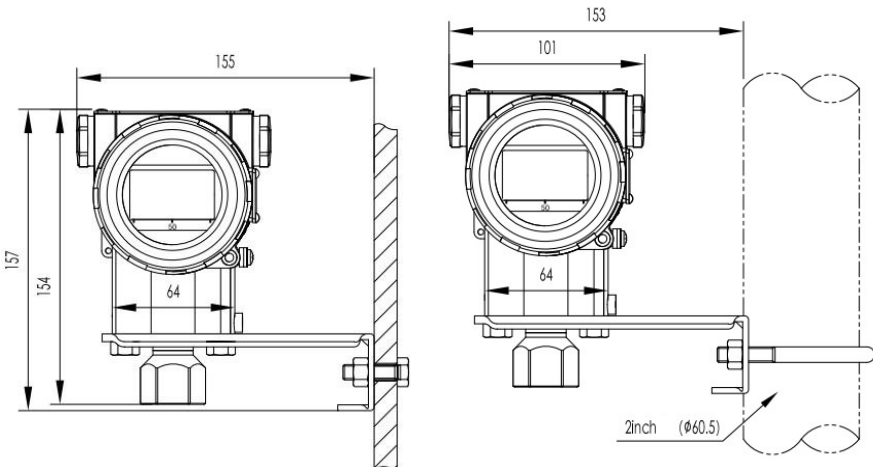

Figure 3 Pressure Transmitter Mounting For Pipe or Wall

Operation Instruction

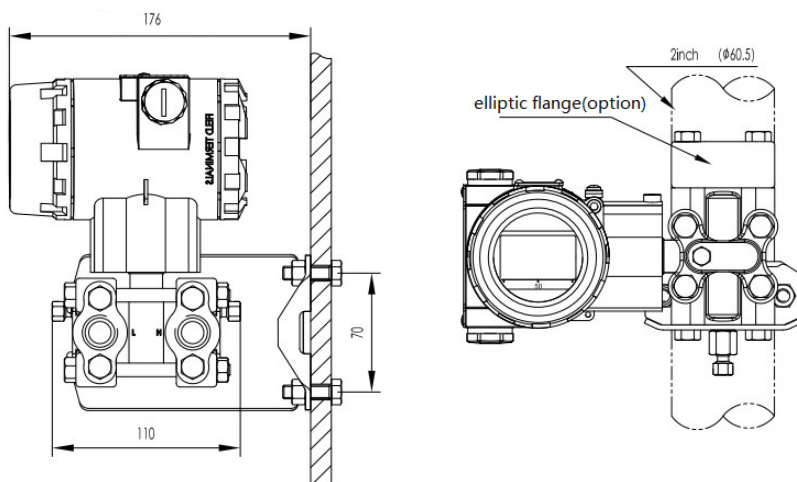

Figure4 Differential Pressure Transmitter Mounting For Pipe or Wall

For proper installation, please follow:

1. Impulse piping should be as short as possible, and avoid anxious bent.
2. Guiding pipe's installation slope should not be less than 1:12, so as not to initiate the precipitation.
3. Before guiding pipe is mounted on the transmitter, it must be cleared by compressed air or measuring medium. The measuring medium is best.
4. If medium is liquid, the guiding pipe should be empty.
5. Pressure piping layout should be ensured that the measured bubbles in the liquid or gas measured sediments can return to the process piping.
6. Process piping must not have any leaks.

■ Electrical Installation

Warning: For hazardous places (i.e. with fire and explosion danger zone) installation, ensure compliance with safety signs safety precautions before electrical connecting. Or it may cause fire and explosion.

Electrical installation must follow the relevant guidance procedure!

The transmitter is without power switch, so the system must be configured for overcurrent protection or the power cut-off device.

Check whether the working voltage is in accord with nameplate. Power supply and output signals share in a pair of wire. The wire can be connected to the terminal connection through the M20x1.5 cable entrance. The wire connecting terminal can be connected with a maximum cross section of 2.5mm wire.

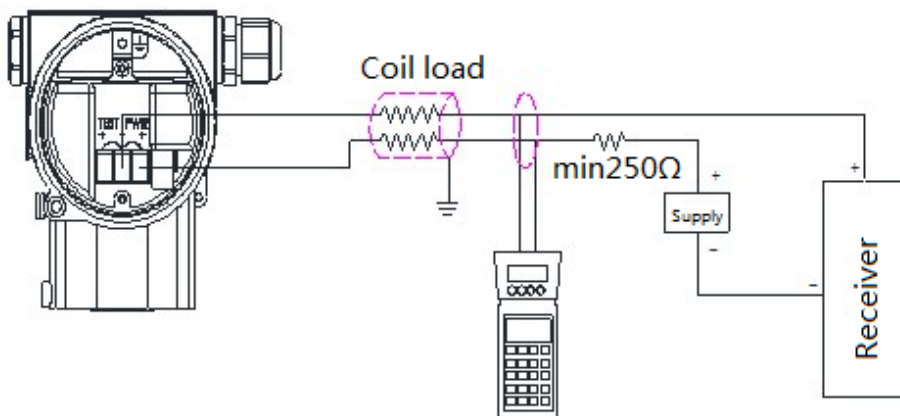

Figure5 Electrical Connection Diagram

Operation Instruction

Transmitter can be operated through the PC machine or notebook computer via modem. Modem can be connected in parallel to the signal circuit at arbitrary point. The modem communicates with the transmitter through an AC signal superimposed on the 4~20mA output signals. This modulation does not change in the mean values, so does not affect the measurement signal. The resistance between the modem and the power supply device must not be less than 250 Ohm. If not achieve this standard value, should add resistance.

■ Use

Installing the transmitter after the power is switched on, it can be put into operation.

·Each of the following must be checked before electrified: :

——Process connection

——Electrical connection

——Guiding pipe of the transmitter and a measuring chamber are filled with dielectric.

·Put into operation, follow the step operate cut-off valve.

Turn on the cut-off valve to connect with pressure;

Turn on the balance valve on the three-valves cluster (Differential pressure transmitter Only);

Turn on the cut-off valve of the higher pressure cavity;

Turn off the balance valve (Differential pressure transmitter Only);

Turn on the cut-off valve of the lower pressure cavity (Differential pressure transmitter Only);

·For exiting operating transmitter, reverse steps.

4 ~ 20mA output signal Note: When measuring pressure is within the subject range of the nameplates, output current signal is in 4~20mA.

Operation Instruction

When the pressure is lower than the calibration of the measuring range, the output signal is between 3.9~4mA. When the pressure is higher than the calibration of the measuring range, the output signal is between 20~20.5mA. Output limit: $I_{min}=3.9mA$, $I_{max}=20.5mA$.

Alarm current mode can be set. The low mode (min) is 3.7 mA. The high mode (max) is 21 mA. No-report mode (keep) is the effective value before the fault happening. Standard setting is the high mode.

·Zero calibration

Because of zero offset caused by installation, the transmitter is needed to do digital zero adjustment.

The specific method for the next chapter: Menu Operations.

The control buttons of the transmitter are on the top of the transmitter. If needed, loosen the screw of the nameplates and rotate it 90 degree; the following figure6 shows the control button:

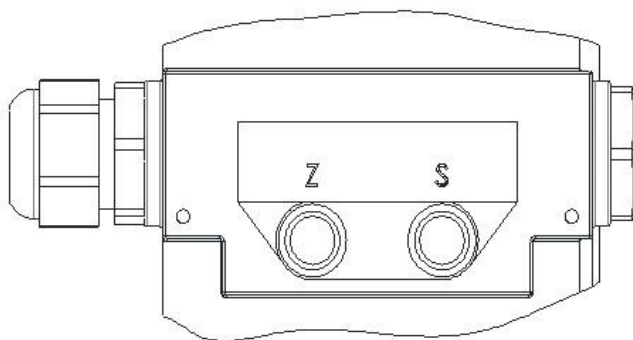

Figure6 Control Button

· Zero and span calibration

To calibration smart transmitter using the following method:

- 1) Through operating control button;
- 2) Through communicator;

3) Through PC configuration software.

The first method is detailed in the "Menu Operations";

■ Menu Operate

When the transmitter is configured LCD, it can be adjusted through the button (Z) and (S) on the top of the transmitter, the following Figure7 and Figure8 show the LCD display and the menu structure:

- Exit menu (EXIT)
- View the measured and calculated values (VIEW)
- Current pressure is set to 0% (GET 0%)
- Current pressure is set to 100% (GET 100%)
- Value input is set to 0% (SET 0%)
- Value input is set to 100% (SET 100%)
- Zero correction (SHIFT ZERO)
- Offset shift (OFFSET SHIFT)
- Damping Adjustment (DAMPING)
- Display Type Selection (DISPLAY)
- Unit selection (UNIT)
- Output characteristic selection (FUNCTION)

Operation Instruction

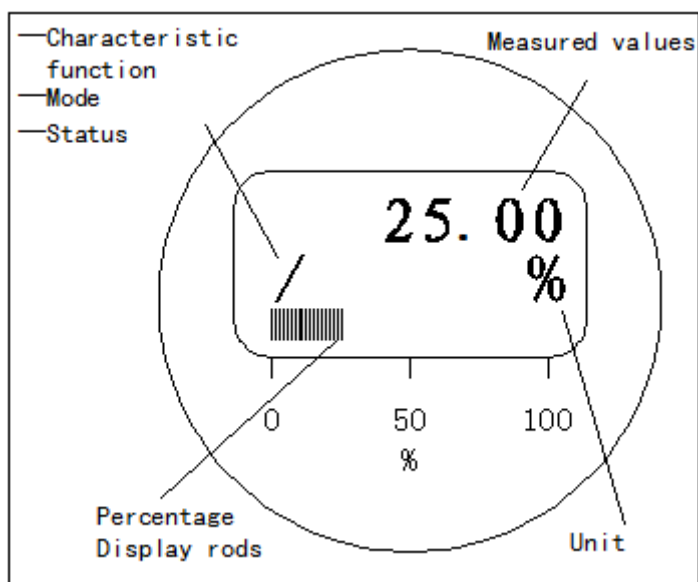

Figure7 LCD Display

Operation Instruction

"Confirm" key to start

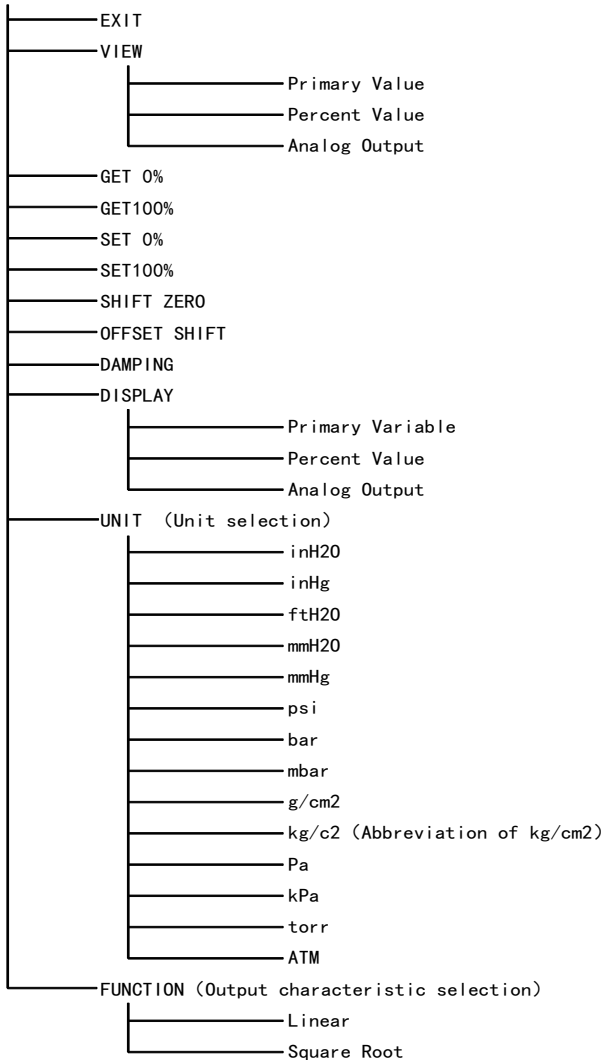

Figure8 Menu Structure

Instructions:

1. Button definition

There are following three combinations for the button "Z" and button "S":

1.1 Key "Confirm": Press the button "Z" and "S" together and keep them for 0.2~10 seconds and then release them together; That this operation is executed every time means enter "Confirm" once;

1.2 Key "Left": Press the button "Z" and keep it for 0.2~10 seconds and then release it. That this operation is executed every time means enter "Left" once;

1.3 Key "Right": Press the button "S" and keep it for 0.2~10 seconds and then release it. That this operation is executed every time means enter "Right" once.

2. The menu startup and exit

2.1 In the state when the menu is not started, enter "Confirm" , the menu will be started, as shown in Figure 9:

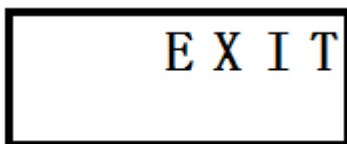

Figure9

2.2 In the state shown in Figure 9, enter "Confirm" key to exit the menu, menu state return to initial state.

3. Menu Browser

After starting the menu, enter the "left" key and "right" keys to navigate the menu.

3.1 Enter "Left" display the menu items from lower to upper circular when the screen displays as shown in Figure 9,enter "Left" once, as shown in Figure 10.Enter "Left" once again, as shown in Figure 11.

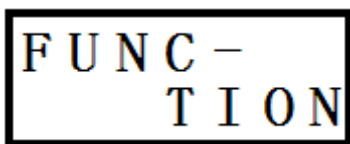

Figure10

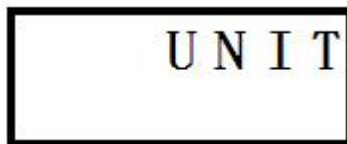

Figure11

3.2 Enter "Right" display the menu items from lower to upper circular when the screen displays as shown in Figure 9, enter "Right" once, as shown in Figure 12. Enter "Right" once again, as shown in Figure 13.

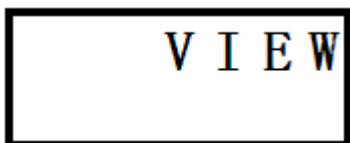

Figure12

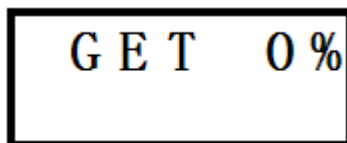

Figure13

4. Menu item selection

When browsing menu, enter "Confirm" once, the corresponding menu function will be executed.

5. Data entry

When user need to set the device variable through the menu, there are two kinds of method to enter the data:

5.1 Data selection

For example: Assuming the current unit is "kPa", the unit need to be set to "bar", user can carry out it according to the following procedures:

5.1.1 Enter "Confirm" once to start menu, as shown in Figure 9;

5.1.2 Enter "Left" twice or "Right" ten times, as shown in Figure 11;

5.1.3 Enter "Confirm" once to get into the unit setting function, as shown in figure 14;

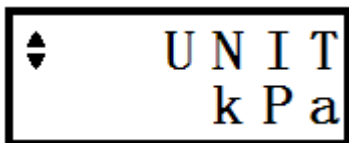

Figure14

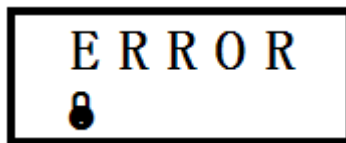

Figure15

5.1.4 Enter "Left" five times or "Right" nine times, as shown in Figure 16;;

5.1.5 Enter "Confirm" once, unit will be set to "bar" and the screen will display message, as shown in Figure 17;

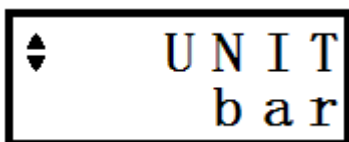

Figure16



Figure17

5.1.6 Enter "Confirm" once to clear message and menu state return to initial state, as shown in Figure 11;

5.1.7 Enter "Left" ten times or "Right" twice, as shown in Figure9;

5.1.8 Enter "Confirm" once to exit menu.

5.2 Data Edit

For example: Assuming the current damping is 0.1s, user need to set the damping to 1.0s, user can carry out it according to the following procedures:

5.2.1 Enter "Confirm" once to start menu, as shown in Figure 9;

5.2.2 Enter "Left" four times or "Right" eight times, as shown in Figure18;

Operation Instruction



Figure18

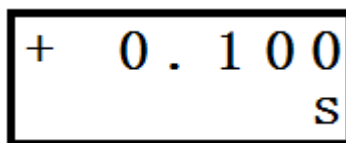

Figure19

5.2.3 Enter "Confirm" once, as shown in Figure 19;

5.2.4 Enter "Left" once or "Right" once to enter data edit mode, at this time, a blinking cursor will appear on the character above the damping unit "S";

Tips:

Cursor blink: When cursor blinking, cursor appears as shown in Figure 20; when cursor disappears, the screen will still show the original character;

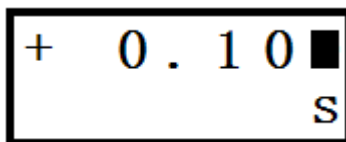

Figure20

Cursor move: After entering data edit mode, every time enter "Left", the cursor move to the left a bit. If this bit is decimal, the cursor automatically move left one ; if it is the leftmost bit, then move the cursor to the right one.

Numerical edit: Enter "Right" once to modify the numerical.

5.2.5 Enter "Left" twice to move cursor to character "1";

5.2.6 Enter "Right" nine times to modify character from "1" to "0";

5.2.7 Enter "Left" twice to move cursor to leftmost character "1";

5.2.8 Enter "Right" once to modify character from "0" to "1", as shown in Figure21;

5.2.9 Enter "Confirm" once ,Damping will be set to 1.0s, and the

Operation Instruction

screen will display message, as shown in Figure17. If the input data is outside the scope of program allows, the program will prompt an error, as shown in Figure 22. At this point, it is need to enter once again the "Confirm" button to clear the error message and back menu to browse State, the display appears as shown in Figure 18.

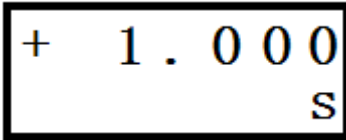

Figure21



Figure22

5.2.10 Enter "Confirm" once to clear the message and return to menu, as shown in Figure18;

5.2.11 Enter "Left" eight times or "Right" four times (menu browse), as shown in Figure 9;

5.2.12 Enter "Confirm" once to exit the menu.

Operation Guide

1. Menu start and exit

1.1 Enter "Confirm" once to start menu when menu doesn't start, then the screen displays as shown in Figure9;

1.2 In the State as shown in Figure 9, enter "Confirm" once to exit the menu.

2. Variable view

2.1 Start menu;

2.2 Browse via the menu, select the "VIEW" menu, the display appears as shown in Figure 12;

2.3 Enter "Confirm" once to enter the variable view. The first variable appears "current pressure/differential pressure value", engineering units and their serial numbers, as shown in Figure 23 (assuming the

Operation Instruction

engineering units is "kPa");

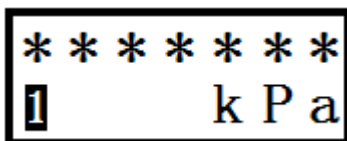

Figure23

Tip : "***" represents the uncertainly pressure/differential pressure value.**

2.4 Enter "Right" once, the screen display the second variable "current pressure/differential pressure value relative to the percentage value of the quantum", and the percent "%" and their series number, as shown in Figure 24;

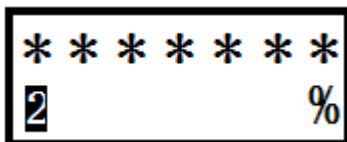

Figure24

Tip : "***" represents the uncertainly pressure/differential pressure percent.**

2.5 Enter "Right" once, the display the third variable "output current value", unit "mA" and their series number, as shown in Figure 25;

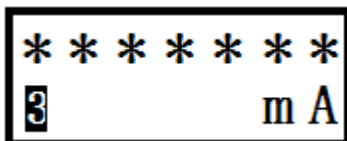

Figure25

Tip: "***" represents the uncertainly output current.**

2.6 Enter "Right" key once, the screen displays the first variable

again, as shown in Figure 23;

2.7 If you type "Left" key, the screen will display the first, second, third variables in reverse chronological order;

2.8 Enter "Confirm" button, return to menu browse status, the display appears as shown in Figure 12.

Tip: In the "VIEW" menu functions, "Left" and "Right" functionality similar to menu browse.

3. Zero migration for measuring range (apply pressure)

For example: There is a differential pressure transmitter (URL is 40kPa; site measuring range is from 0 to 20kPa) is installed on the project. Actually in the pipeline when the differential pressure is 0~20kPa, the display appears as 0.1~20.1kPa and output 4.08~20.08mA.

Requirement: The display of screen does not change, the output current value is set to 4~20mA.

Steps are as follows:

3.1 Make the pressure of pipeline is 0kPa, the screen displays +0.1kPa;

3.2 Start and browse the menu and then select "GET 0%" menu item, as shown in Figure 13;

3.3 Enter "Confirm" once, the measuring range will be set to 0.1~20.1kPa automatically and the screen will display a message, as shown in Figure 17;

3.4 Enter "Confirm" once to clear the message and return to the menu, as shown in Figure 14.

3.5 Using "VIEW" menu item, the first variable is 0.1kPa at this time, the third variable is 4mA;

3.6 Make the pressure of pipeline is 20kPa;

3.7 Using "VIEW" menu item, the first variable is 20.1kPa at this time,

Operation Instruction

the third variable is 20mA;

3.8 Exit the menu.

4. Full scale set for measuring range (apply pressure)

For example: There is a differential pressure transmitter (URL is 40kPa; measuring range is from 0 to 40kPa) installed on the project site. Actually in the pipeline when the differential pressure is 0~20kPa, the display appears as 0~20kPa and output 4~12mA.

Requirement: The display of screen does not change, the output current value is set to 4~20mA.

Steps are as follows:

4.1 Make the pressure in pipeline is 20kPa, and the screen displays +20kPa;

4.2 Start and browse the menu and then select "GET 100%" menu item, as shown in Figure 26;

4.3 Enter "Confirm" once, the measuring range will be set to 0~20kPa automatically and the screen will display message, as shown in Figure17;

4.4 Enter "Confirm" once to clear the message and return to the menu, as shown in Figure26.

4.5 Using "VIEW" menu item, the first variable is 20kPa at this time, the third variable is 20mA;

4.6 Make the pressure in pipeline is 0kPa,

4.7 Using "VIEW" menu item, the first variable is 0.1kPa at this time, the third variable is 4mA;

4.8 Exit the menu.

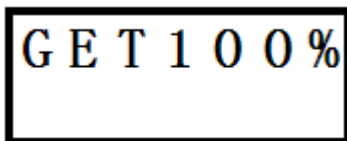

GET 100%

Figure26

5. Zero shift for measuring range (input variable)

For example: There is a differential pressure transmitter (URL is 40kPa; measuring range is from 0 to 20kPa) installed on the project site. Actually in the pipeline when the differential pressure is -4~20kPa, the display appears as -4~20kPa and output 3.9~12mA.

Requirement: The display of screen does not change, the output current value is set to 4~20mA.

Steps are as follows:

5.1 Start and browse the menu and then select "Set 0%" menu item, as shown in Figure 27;

5.2 Enter "Confirm" once and the screen will display LRL (0kPa), as shown in Figure28;

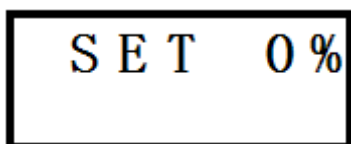

SET 0%

Figure27

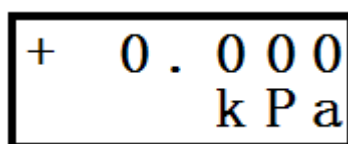

+ 0.000
kPa

Figure28

5.3 Enter "Left" once or "Right" once to enter date edit state, a blinking cursor appears on the screen;

5.4 Enter "Left" three times to move the cursor to the first character on the left;

5.5 Enter "Right" four times to change the character from "0" to "4";

5.6 Enter "Left" twice to move the cursor to the character "+";

5.7 Enter "Right" once to change the character from "+" to "-", as shown in Figure 29;

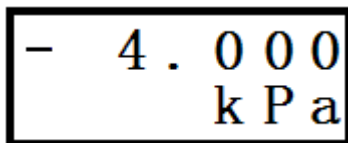

Figure29

5.8 Enter "Confirm" once, the modify will be apply, and the screen will display as shown in Figure17;

5.9 Enter "Confirm" once to clear the message and return to menu, the screen will display as shown in Figure 27;

5.10 Make the differential pressure is -4kPa in Pipeline;

5.11 Using "VIEW" menu item, the first variable is -4kPa at this time, the third variable is 4mA;

5.12 Make the differential pressure is 20kPa in pipeline;

5.13 Using "VIEW" menu item, the first variable is 20kPa at this time, the third variable is 20mA;

5.14 Exit the menu.

6. Full scale set for measuring range (input variable)

For example: There is a differential pressure transmitter (URL is 40kPa; measuring range is from 0 to 40kPa) installed on the project site. Actually in the pipeline when the differential pressure is 0~20kPa, the display appears as 0~20kPa and output 4~12mA.

Requirement: The display of screen does not change, the output current value is set to 4~20mA.

Steps are as follows:

6.1 5.1 Start and browse the menu and then select "Set 100%" menu item, as shown in Figure 30;

6.2 Enter "Confirm" once, and the screen will display URL (40kPa), as shown in Figure31;

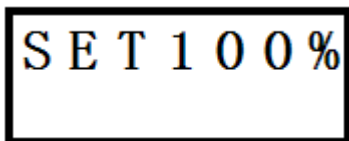

SET 100%

Figure30

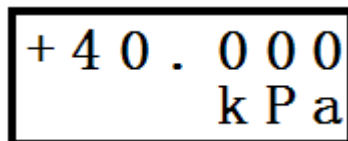

+ 40.000
kPa

Figure31

6.3 Enter "Left" once or "Right" once to enter date edit state, a blinking cursor appears on the screen;

6.4 Enter "Left" Four times to move the cursor to the character "4";

6.5 Enter "Right" ten times to change the character from "4" to "2", as shown in Figure32;

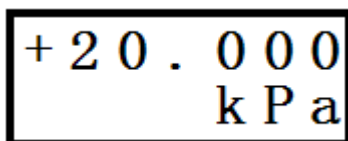

+ 20.000
kPa

Figure32

6.6 Enter "Confirm" once, the modify will be apply, and the screen will display as shown in Figure17;

6.7 Enter "Confirm" once to clear the message and return to menu, the screen will display as shown in Figure 30;

6.8 Make the differential pressure is 0kPa in Pipeline;

6.9 Using "VIEW" menu item, the first variable is 0kPa at this time, the third variable is 4mA;

6.10 Make the differential pressure is 20kPa in pipeline;

6.11 Using "VIEW" menu item, the first variable is 20kPa at this time, the third variable is 20mA;

6.12 Exit the menu.

7. Digital zero adjustment

For example: There is a differential pressure transmitter (URL is 40kPa; measuring range is from 0 to 20kPa) installed on the project site.

Operation Instruction

Actually in the pipeline when the differential pressure is 0~20kPa, the display appears as 0.1~20.1kPa and output 4.08~20.08mA.

Requirement: the screen displays 4~20kPa, the output current value is set to 4~20mA.

Steps are as follows:

7.1 Make the pressure of pipeline is 0kPa, the screen displays +0.1kPa;

7.2 Start and browse the menu and then select" SHIFT" " ZERO" menu item, as shown in Figure 33;

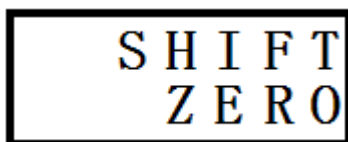

Figure33

7.3 Enter "Confirm" once and the digital zero will be adjusted, and the screen will display message, as shown in Figure17.

7.4 Enter "Confirm" once to clear the message and return to menu, the screen will display as shown in Figure33;

7.5 Using "VIEW" menu item, the first variable is 0kPa at this time, the third variable is 4mA;

7.6 Make the differential pressure is 20kPa in pipeline;

7.7 Using "VIEW" menu item, the first variable is 20kPa at this time, the third variable is 20mA;

7.8 Exit the menu.

8. Measuring range offset shift

For example: There is a differential pressure transmitter (URL is 40kPa; measuring range is from 0 to 40kPa) is installed on the project site. Actually in the pipeline when the differential pressure is -20~20kPa, the display appears as -20~20kPa and output 3.9~20mA.

Operation Instruction

Requirement: the display of screen does not change, the output current value is set to 4~20mA.

Steps are as follows:

8.1 make the pressure of pipeline is 0kPa, the screen displays +0kPa;

8.2 Start and browse the menu and then select" OFFSET" " SHIFT" menu item, as shown in Figure 34;

8.3 Enter "Confirm" once, and the screen will display the percent of the current pressure +0.00%, as shown in Figure35;



Figure34

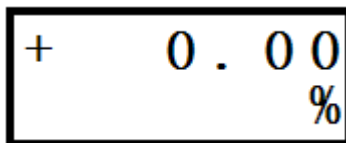

Figure35

8.4 Enter "Left" once or "Right" once to enter date edit state, a blinking cursor appears on the screen;

8.5 Enter "Left" three times to move the cursor to the first left blank character "□";

8.6 Enter "Right" five times to change the character from "□" to "0", as shown in Figure35;

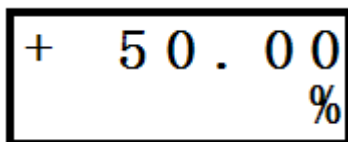

Figure36

8.7 Enter "Confirm" once, the measuring range offset shift will be adjusted, the URL and LRL will be adjusted equally and to the same direction together. Modification is carried out according to the following formula:

Operation Instruction

1) Range = URL - LRL = 40 - 0 = 40kPa

2) Modified percent = Percent after shifted - Percent before shifted = 50.00% - 0.00% = 50.00%

3) Modifier = Range × Modified percent = 40 × 50.00% = 20kPa

4) URL after shifted = Original URL - Modifier = 40 - 20 = 20kPa

5) LRL after shifted = Original LRL - Modifier = 0 - 20 = -20kPa

At the same time, the screen will display the message, as shown in Figure17;

8.8 Enter "Confirm" once to clear the message and return to menu, the screen will display as shown in Figure 34;

8.9 Using "VIEW" menu item, the first variable is 0kPa at this time, the third variable is 12mA;

8.10 make the pressure of pipeline is 20kPa;

8.11 Using "VIEW" menu item, the first variable is 20kPa at this time, the third variable is 20mA;

8.12 Make the pressure of pipeline is -20kPa;

8.13 Using "VIEW" menu item, the first variable is -20kPa at this time, the third variable is 4mA;

8.14 Using " SET 0%" menu item, the LRL is set to -20kPa;

8.15 Using " SET 100%" menu item, the LRL is set to 20kPa;

8.16 Exit.

9. Damping setting

Seen in Menu Operate → 5. Data entry → 5.1 Data Edit.

Tips: The effective range of the damping is 0.1~60seconds.If the variable entered is out of the effective range, it will not be accepted and the screen will display the error message as shown in Figure 22.

10. Display type selection

There are three types of the display, it can be selection in the menu

Operation Instruction

item "display".

For example: Assuming display type is percent value

Requirements: Set the display type to primary variable.

Steps are as follows:

10.1 Start Menu and select "DISPLAY" by entering "Left" or "Right".

The screen displays as shown in Figure 37;



Figure37

10.2 Enter "Confirm" ,the screen displays percent value, as shown in Figure 24;

10.3 Enter "Left" once or "Right" twice, the screen displays the primary variable as shown in figure 23;

10.4 Enter "Confirm" once, display will be set to primary variable, the screen displays as shown in Figure 17;;

10.5 Enter "Confirm" once to clear message and return menu, displayed as shown in Figure 37.

10.6 Exit menu and observe the primary Variable(pressure value) is displayed.

11. Unit setting

Seen in Menu Operate → 5. Data entry → 5.1 Data selection.

12. Characteristic function setting

Characteristic function has two type selection, linear and square root.it could be set through Options "FUNC- " " TION".

For example: Assuming the current characteristic function is linear.

Requirements: Set characteristic function to square root

Operation Instruction

Steps are as follows:

12.1 Start Menu and select "FUNCTION" by entering "Left" or "Right". The screen displays as shown in Figure 10;

12.2 Enter "Confirm" once, and then screen display "Linear" (Current characteristic function state) as shown in Figure 38;

12.3 Enter "Left" or "Right" once, and then screen display "Square Root", as shown in Figure 39;

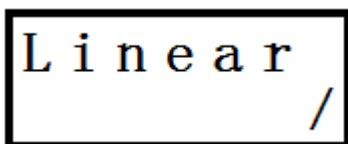

Figure38

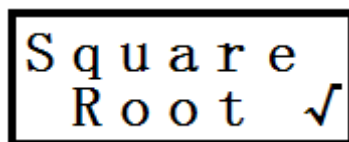

Figure39

12.4 Enter "Confirm" once, characteristic function will be set to square root, the screen displays as shown in Figure 17;

12.5 Enter "Confirm" once to clear message and return menu, displayed as shown in Figure 10.

12.6 After exiting the menu, the current characteristic function has been set to square roots, the screen displays as shown in Figure 40: If characteristic function is set to linear, the screen displays as shown in Figure 41.



Figure40



Figure41

NOTE: "*"means uncertainly display

■ Maintenance

According to the work conditions, inspecting on device's output reference should be at the previous section of periodic. Periodic inspection and cleaning are required according to the condition. Cleaning work would be the best to working indoor. Operation is as follows:

- 1) Release the screws of process flange in accordance with the diagonal;
- 2) Be careful take down the flange and don't scratch on the sensor diaphragm;
- 3) Use soft brush and appropriate solvent to cleaning the sensor diaphragm and the flange;
- 4) Replacement process flange's O-rings;
- 5) Install process flange on the measuring unit, don't touch the isolating diaphragm (Both of the process flange's section must to be keep on the same plane, and hold on the right angle with the watch case);
- 6) Use the torque wrenches to diagonal for tighten in the bolts、nuts and check whether disclosure.

■ Repair

The relevant safety requirements must be followed in the entire process of using. The transmitter could be disassembled on while in the cleaning, inspection, repairing and replacing of failed parts. The transmitter can only be repaired by the manufacturer. The failure of the transmitter should be returned to the manufacturer for repairing, if possible, please describe the problems and causes.

Operation Instruction
